

High Performance Pinless Subsea Connector

WiSub's data transfer technology attains never-before achieved speeds in pinless connection, starting with a 200Mbps transparent Ethernet & serial interface. The convergence of this disruptive solution with proprietary inductive coupling has resulted in a flexible connection solution delivering unlimited wet-mate cycles and loose mating tolerances, enabling the development of new opportunities for underwater equipment manufacturers and operators.

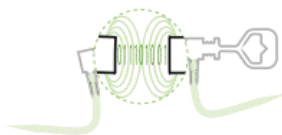

Connecting freedom
Misalignment tolerance
360° rotation
Infinite mating cycles



Data + Power Transfer
From 200Mbit/s
Ethernet & serial data formats
Fiber optic & copper interfaces

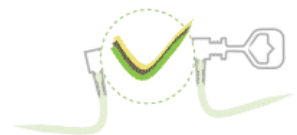

Standardized interface
Genderless mating faces
Flexible mounting features
Latching & packaging options

POWER TRANSFER

Power transfer	180W*
GAP	0-10mm**
Output Voltage	User selectable 12 to 30 VDC
Input Voltage Range	20-30VDC
Output Current	0-9.4A (limited by max power of 180W)
Power start-up time	5-20s
Protection	Current, temperature, foreign object detection, reverse power
Efficiency 180W	83%
Max constant current limit	9.4A (adjustable)
Max step	180W
Max load drop	180W
Battery charging (CC/CV)	System can be configured to charge battery packs from 4S to 7S. Constant current can be set to match cell charging current up to max 9.4A

* Larger gaps will result in a decrease in the transferable power (10mm approx. 100W)

** In air, larger gaps will require additional heat dissipation

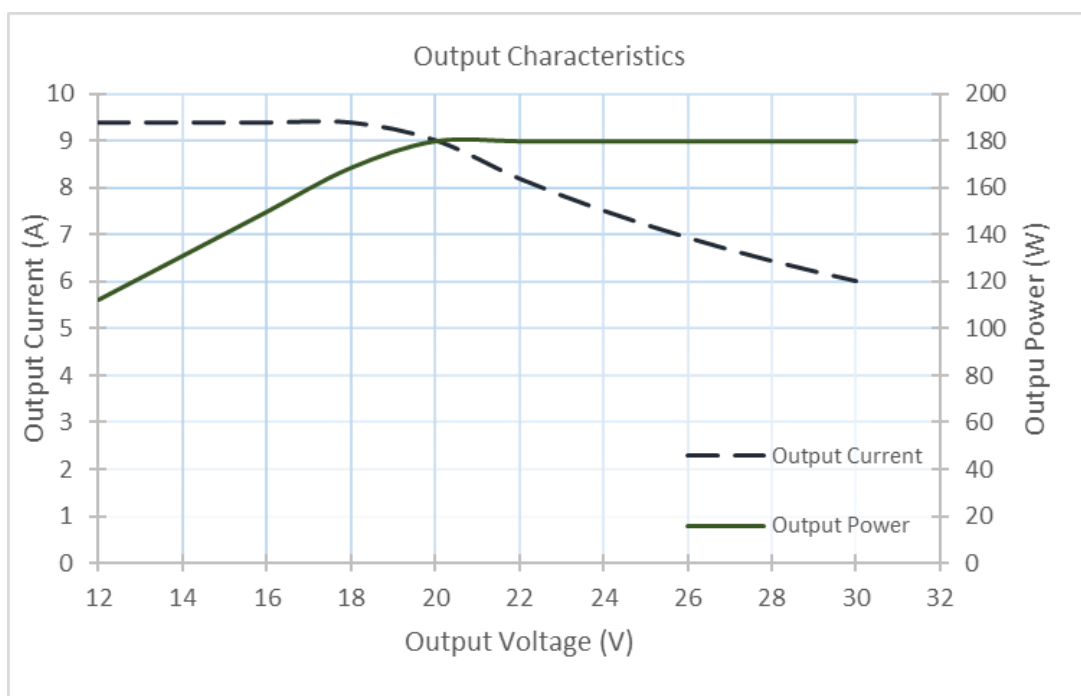

DATA TRANSFER

Ethernet transfer rate	Starting at 200 Mbit/s
Serial data rate (max)	115200 bps (RS323,RS422,RS485)
Data start-up time	32s

MECHANICAL PROPERTIES

Weight in air	1.3 kg
Weight in seawater	1.1 kg
Housing	Aluminum ¹
Depth rating	3000M

¹ Customer specified materials for housing are possible including 316, Duplex SS, beryllium copper or titanium

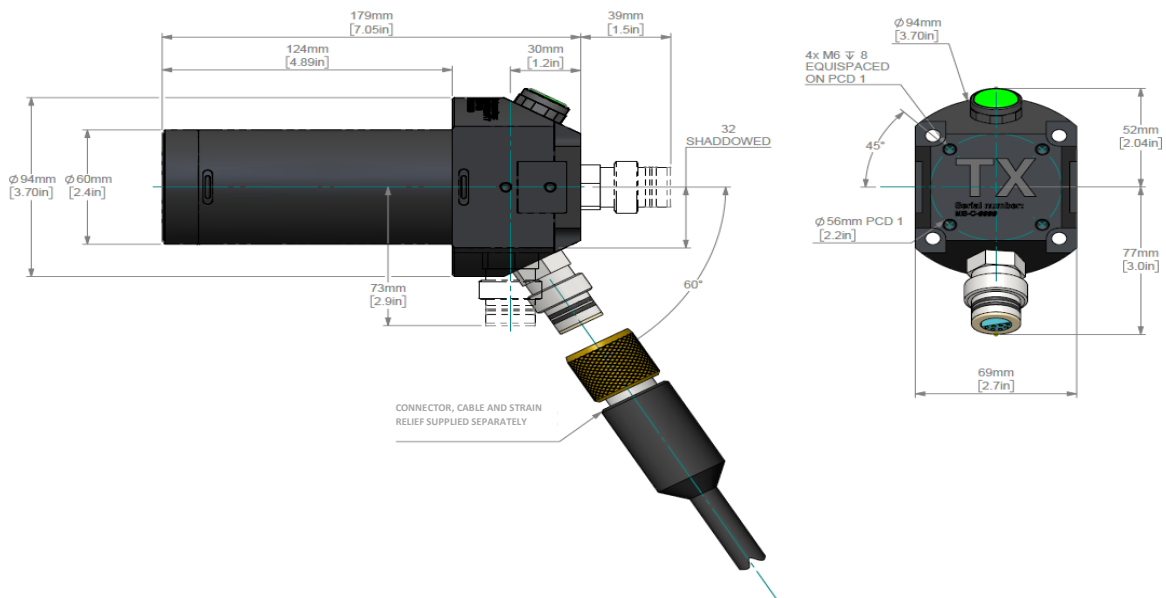

Flexible Operational Tolerances

WiSub pinless connectors overcome sub-millimeter tolerances to offer centimeter tolerances on your subsea connection applications, enabling subsea solutions never before possible with pinned connectors.

Rotational Alignment Tolerance

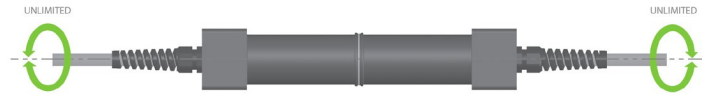

Angular Misalignment Tolerance POWER

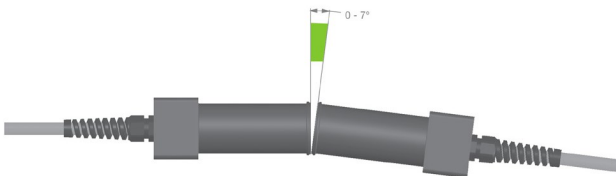

Angular Misalignment Tolerance DATA

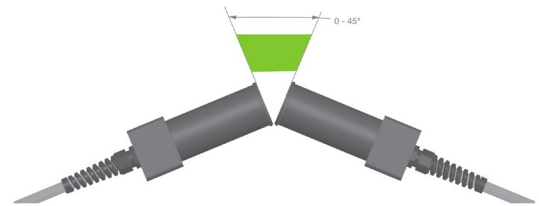

Cross Axis Tolerance POWER



Cross Axis Tolerance DATA



Gap Tolerance POWER

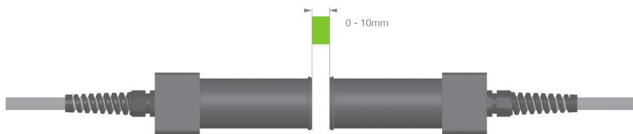

Gap Tolerance DATA

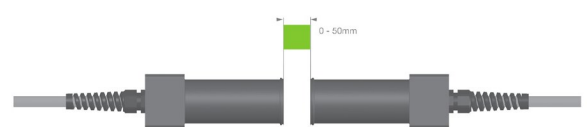

Comparative Advantages

WiSub pinless connectors transfer data through seawater at much higher data rates than many other existing non-contact subsea communications methods, being based on WiSub high-speed, high-frequency microwave electronics vs. low-frequency RF, inductive or acoustic technologies.

Advantages over legacy “plug-in” wet-mate connectors include galvanic separation, alignment freedom, immunity against seal contamination and unlimited mating cycles.

WiSub pinless connectors are unaffected by acoustic disturbance and turbidity, or by marine growth that might affect optical systems. Driving electronics and transducers are optimized for through-water transmissions. Low-frequency inductive power transfer and high-frequency data transfer solutions peacefully co-existing without interference.

Transmark Subsea AS
Nedre Nøttveit 16
5238 Rådal, NORWAY
+47 56 91 39 00



Transmark Subsea Ltd.
Unit 6, Wellington Business Park
Wellington Circle
Aberdeen AB12 3JG, UNITED KINGDOM
+44 12 24 51 82 60